

ALLEGATO E)

DISEGNI LOTTI 1 – 2 – 3– 4 – 5– 7 – 9

Lotto 1 INFANT

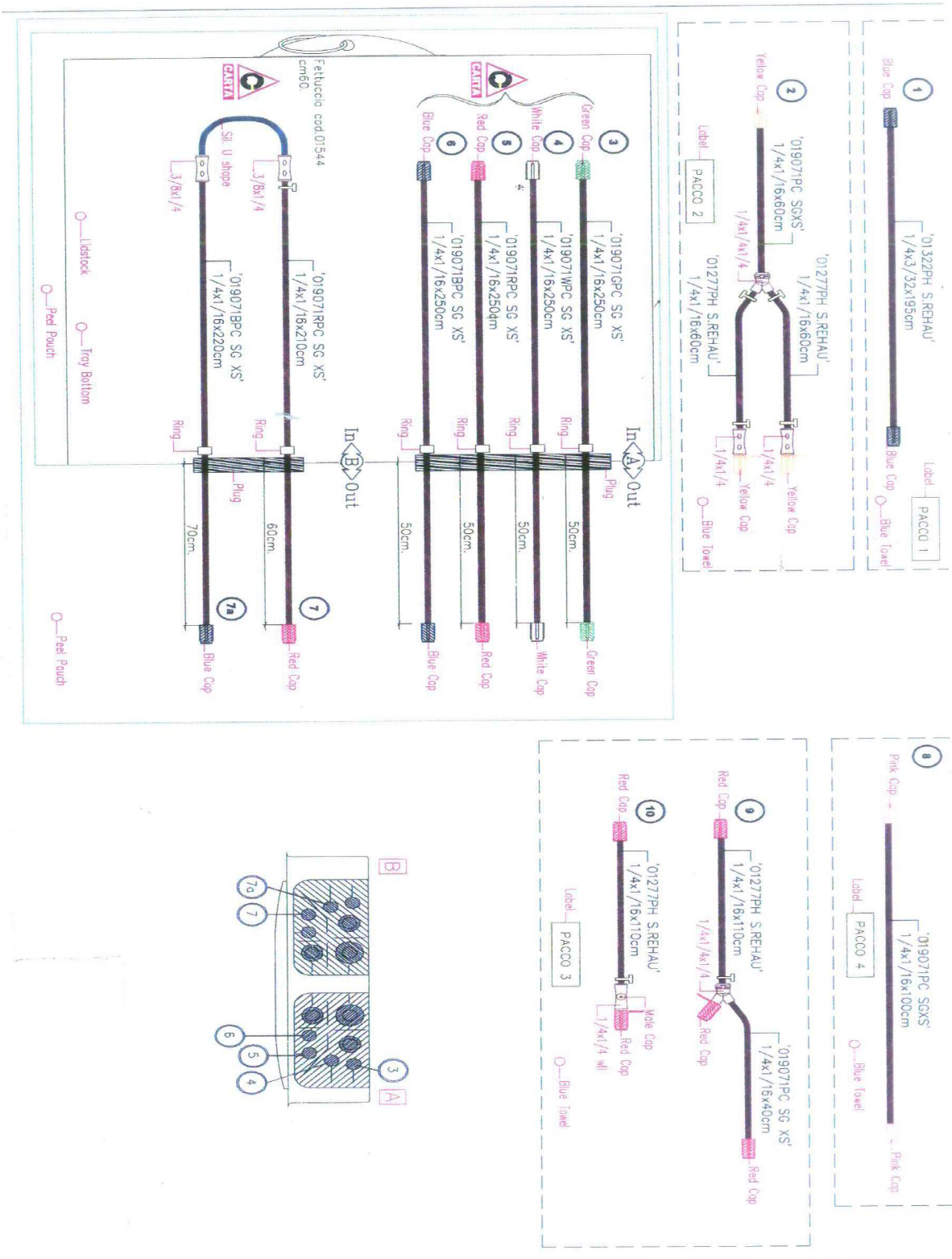

Lotto 2 ad.piccola taglia – pag.1

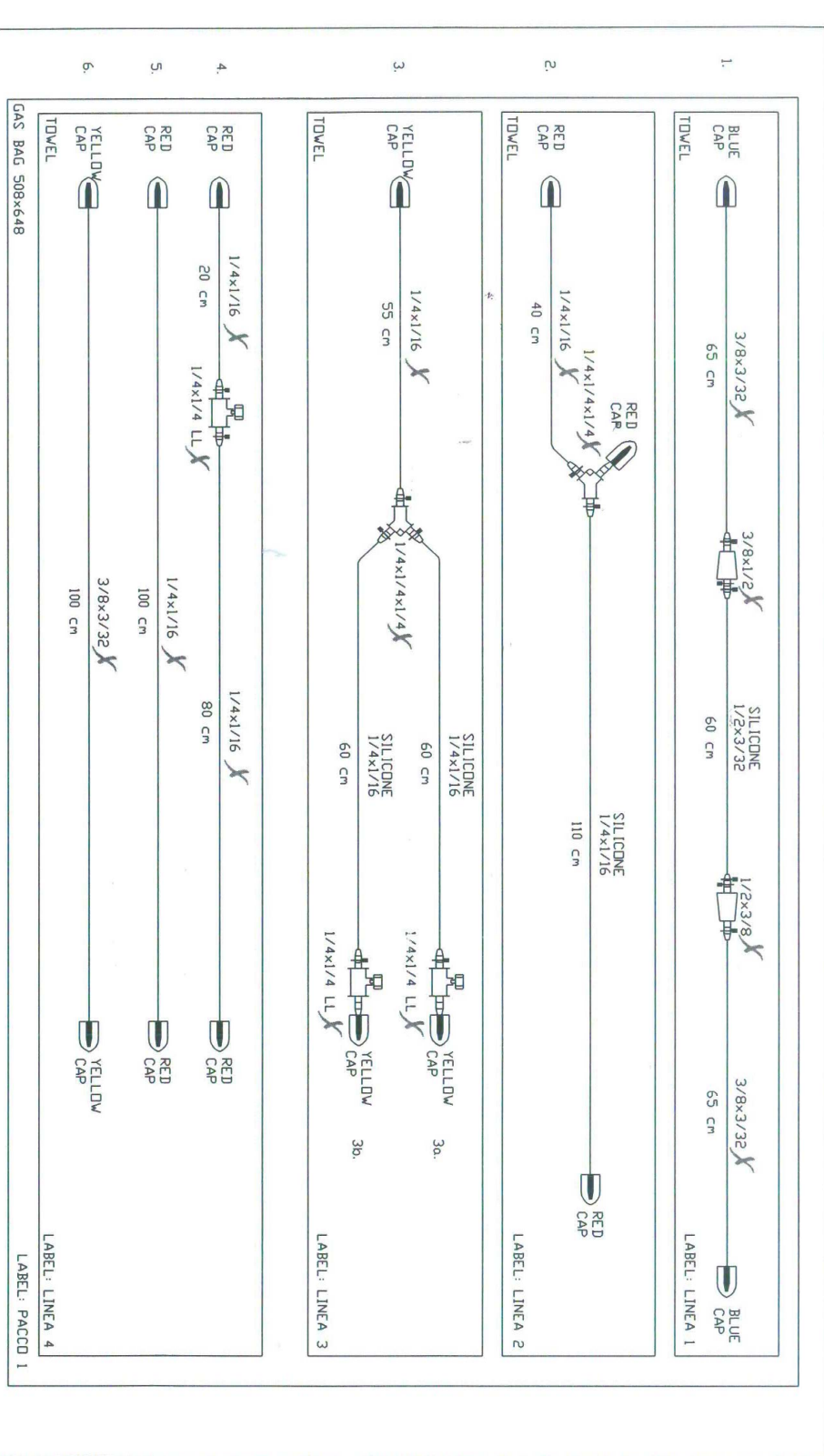

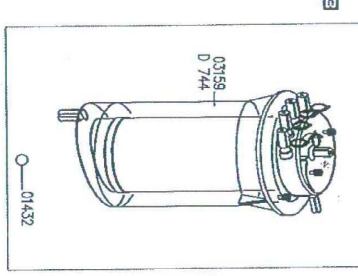
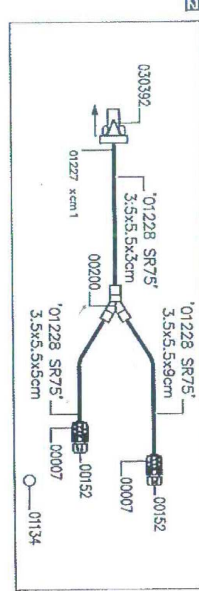
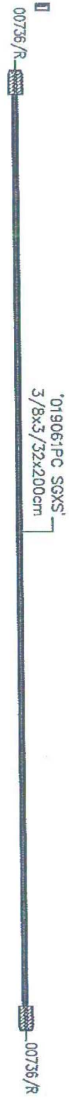

S.ORSOLA (BO)
COD.3159 D744
C.P. 83039
S.O.
EXP. DATE... 01831T

Introdurre l'etichetta all'interno dello scottolo singolo, senza applicarla.

Lotto 7 A

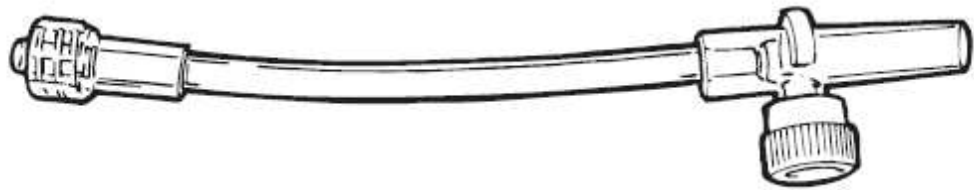

Lotto 7B

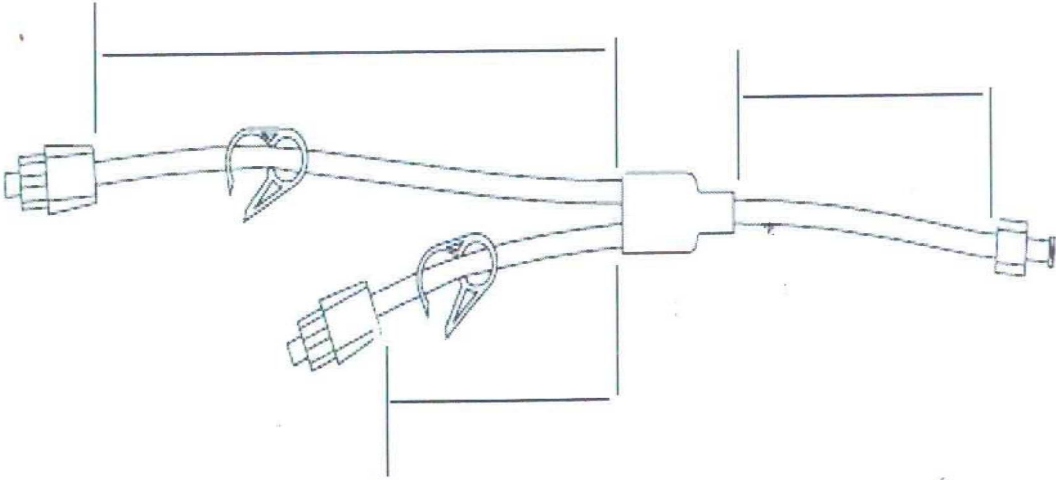

Lotto 7C

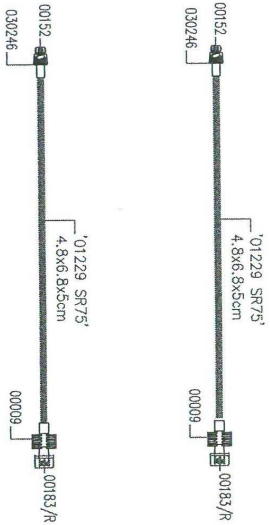

Lotto 7 D

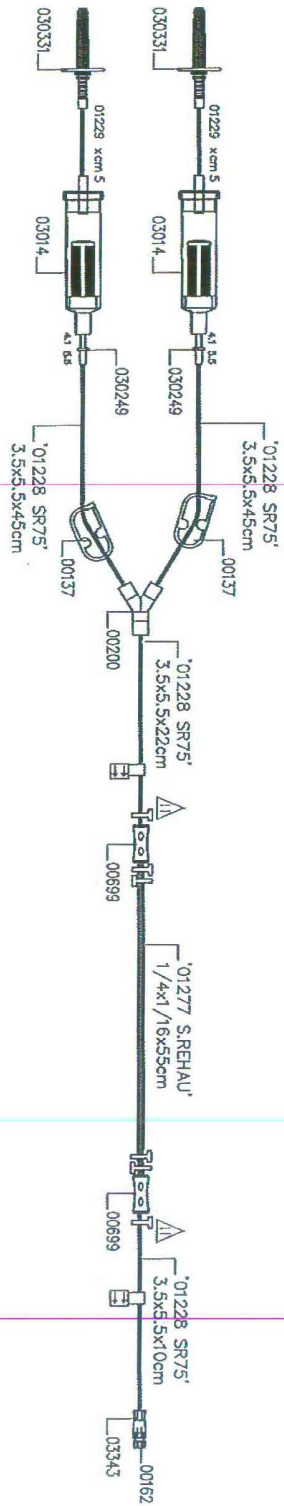

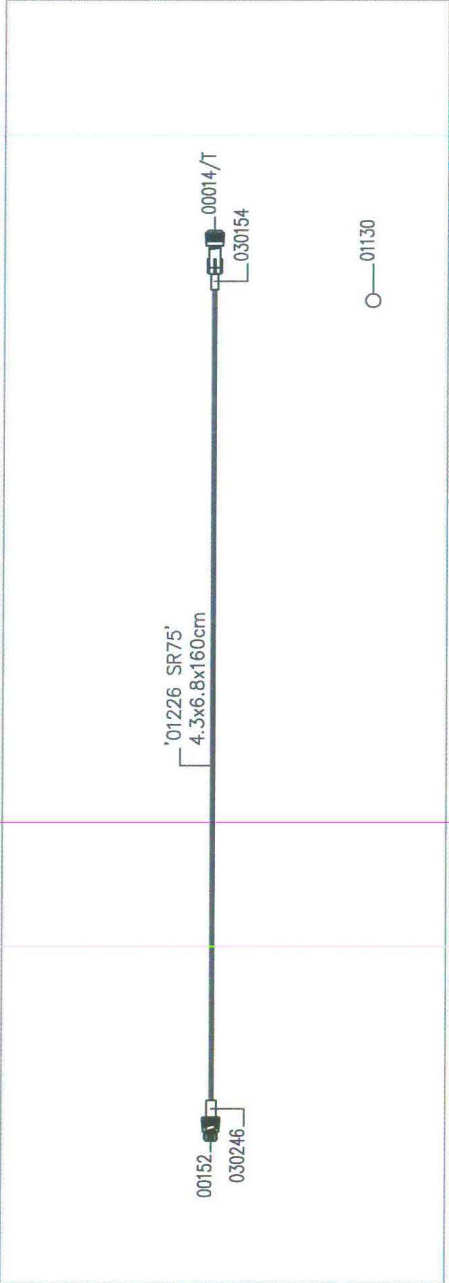

Lotto 7 F

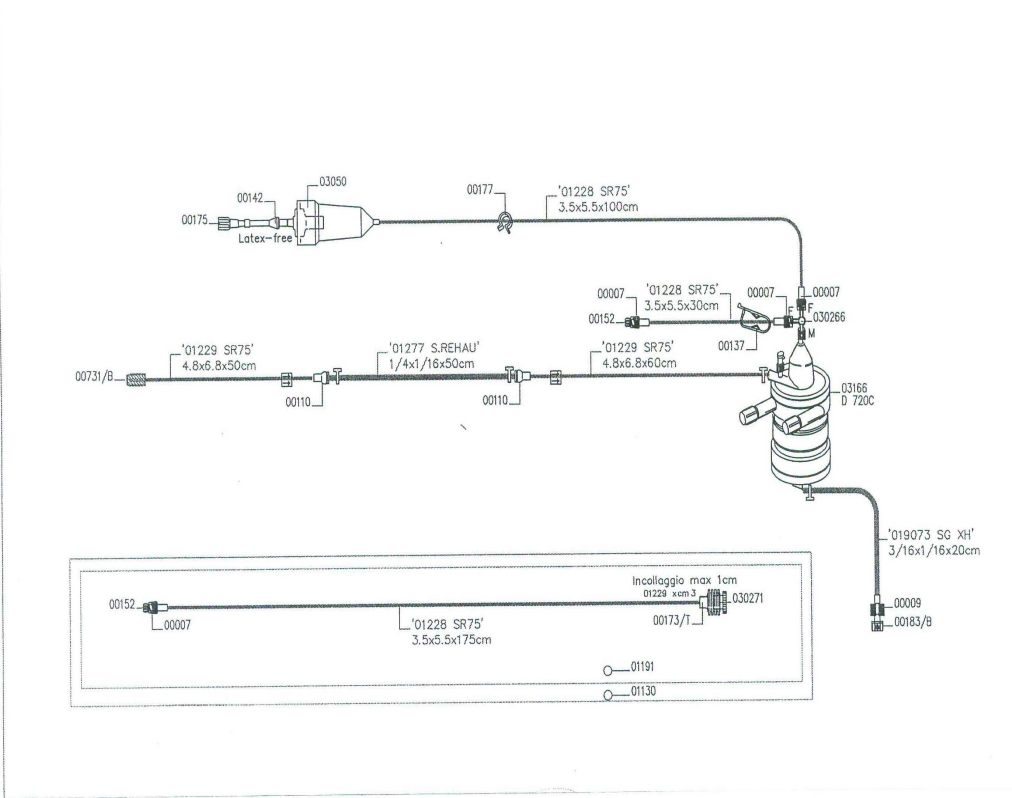

Lotto 7G

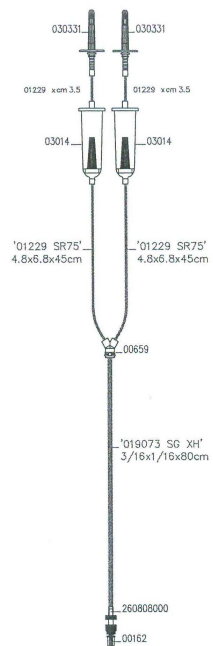

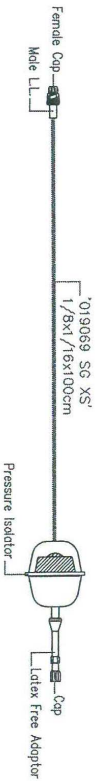

Lotto 7 I

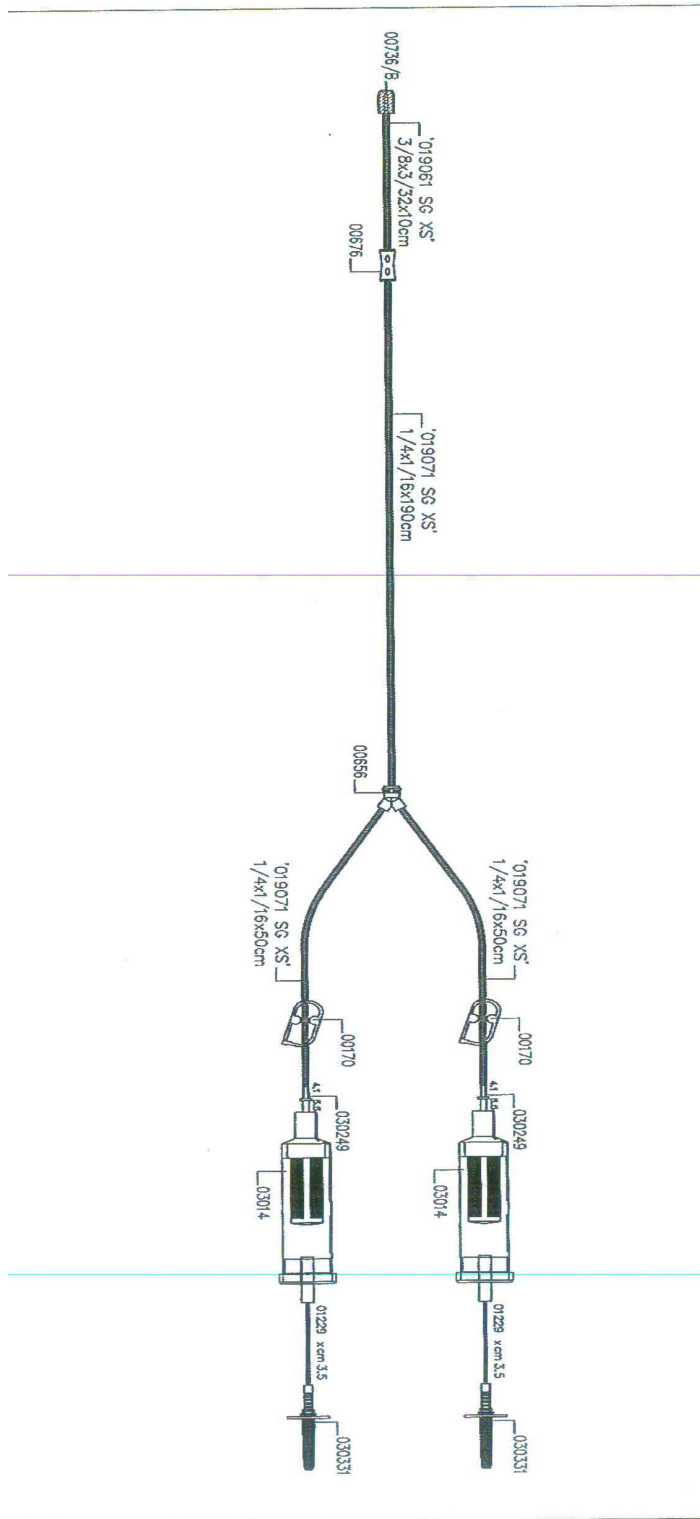

Lotto 9A

00733/P — 019071 SG XS
1/4x1/16x100cm — 00733/P

Lotto 9 B

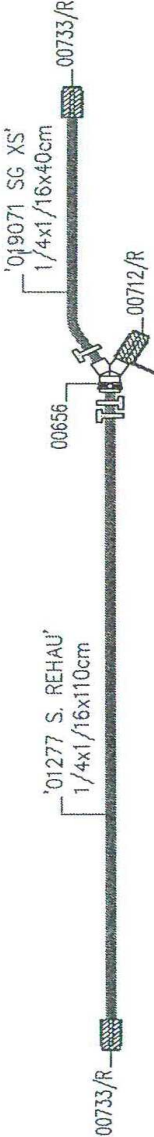

Lotto 9 C



00736/R- [Barcode] '019061 SG XS'
3/8x3/32x210cm [Barcode] 00736/R

Lotto 9 D

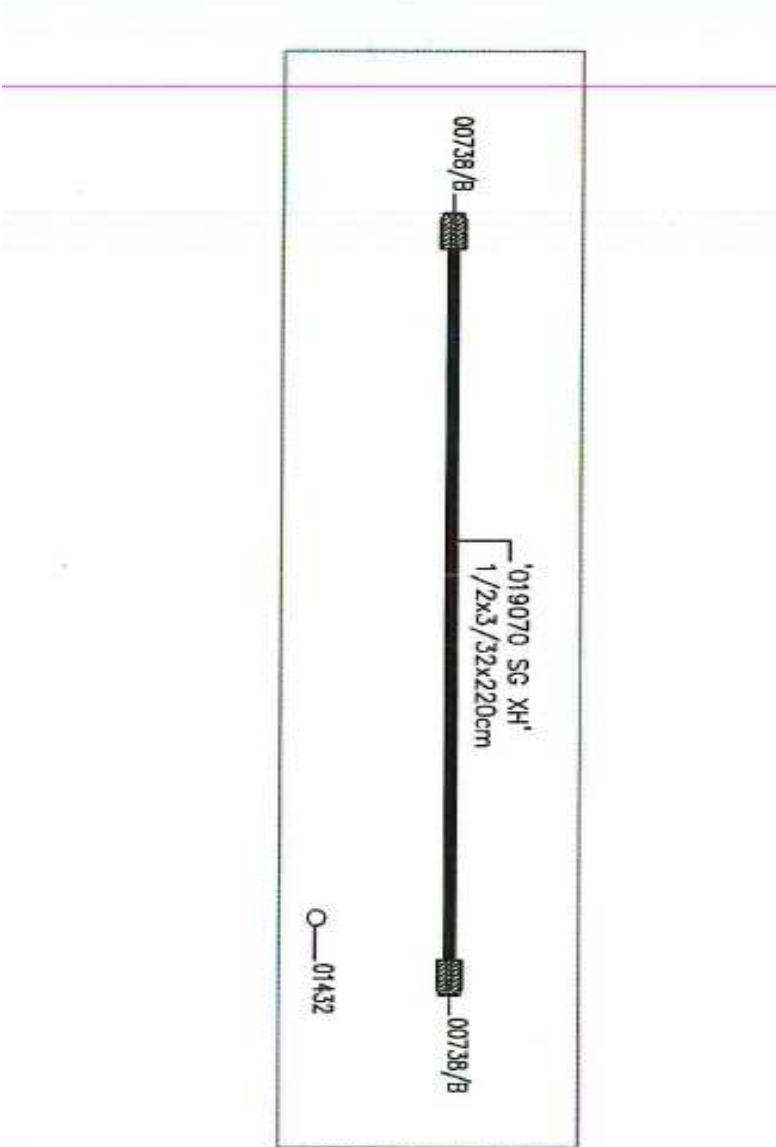

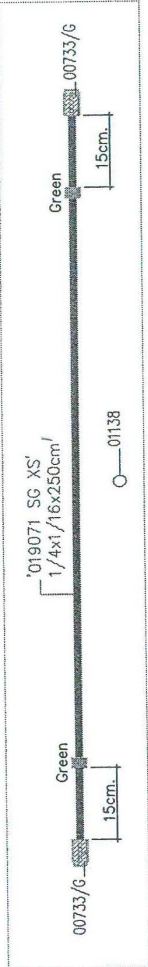

Lotto 9 F

